

# MASTERLINE 10-HI RENAISSANCE DOORS INWARD

OPDEKDEUR  
FENETRE PORTE  
REBATED DOOR  
FENSTERTUER

 10X

MASTERLINE 10-HI+ GETEKEND  
MASTERLINE 10-HI+ DESSINE  
MASTERLINE 10-HI+ DRAWN  
MASTERLINE 10-HI+ GEZEICHENET

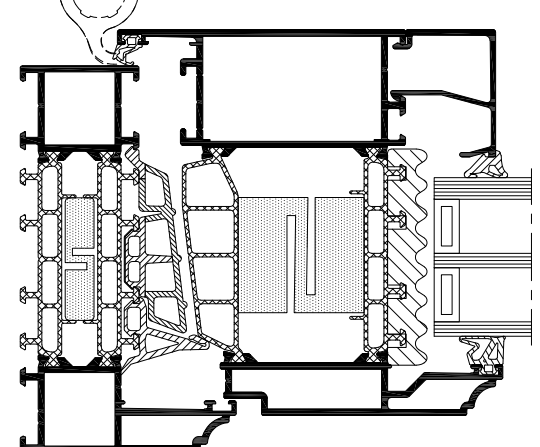

ISOLATIE VARIANT MASTERLINE 10  
ISOLATION VARIANTE MASTERLINE 10  
INSULATION VARIANT MASTERLINE 10  
ISOLATION VARIANTE MASTERLINE 10

MASTERLINE 10 HI+

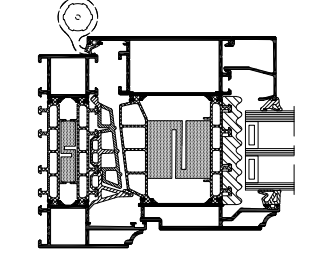

OVERZICHT OPENINGS TYPES  
APERÇU TYPES D'OUVERTURE  
OVERVIEW OPENING TYPES  
ÜBERSICHT ÖFFNUNGSARTEN

DEUR BINNENDRAAIEND  
PORTE OUVRANT VERS L'INTERIEUR  
DOOR INWARD OPENING  
TUER NACH INNEN OEFFNEND



 101a

DUBBELE DEUR NAAR BINNENDRAAIEND  
PORTE DOUBLE OUVRANT VERS L'INTERIEUR  
DOUBLE DOOR INWARD OPENING  
ZWEIFLUEGELIGE TUER NACH INNEN OEFFNEND



 102a

PROFIELOVERZICHT  
APERÇU DES PROFILES  
PROFILE OVERVIEW  
PROFILUEBERSICHT

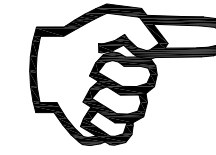
 **I**

HULPPROFIELEN  
PROFILES DE RACCORDEMENT  
ADDITIONAL PROFILES  
ZUSATZPROFILE

 ... .dwg

BOUWAANSLUITINGEN  
RACCORDEMENTS AU BATIMENT  
BUILDING CONNECTIONS  
BAUANSCHLUESSE

 ... .dwg

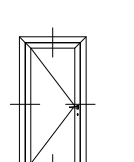
101a 

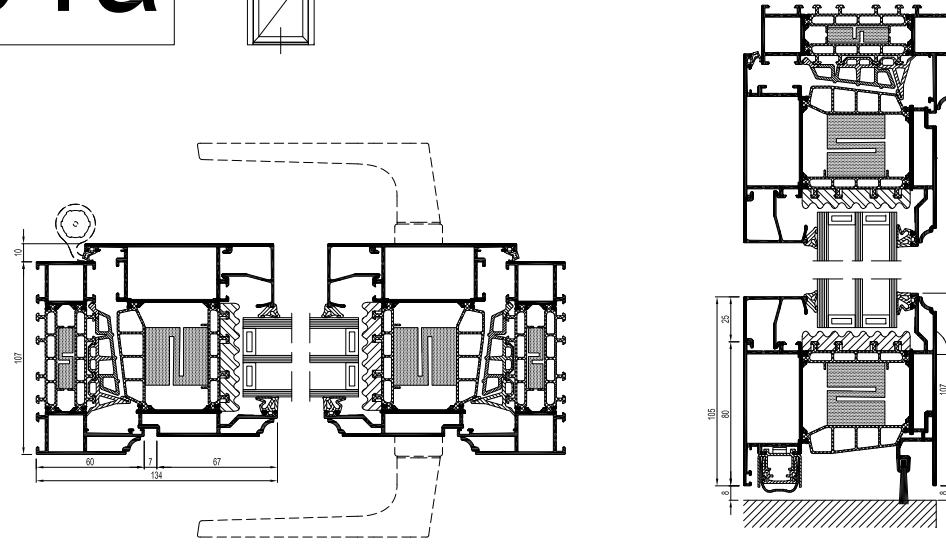

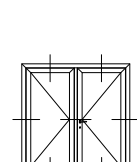
102a 

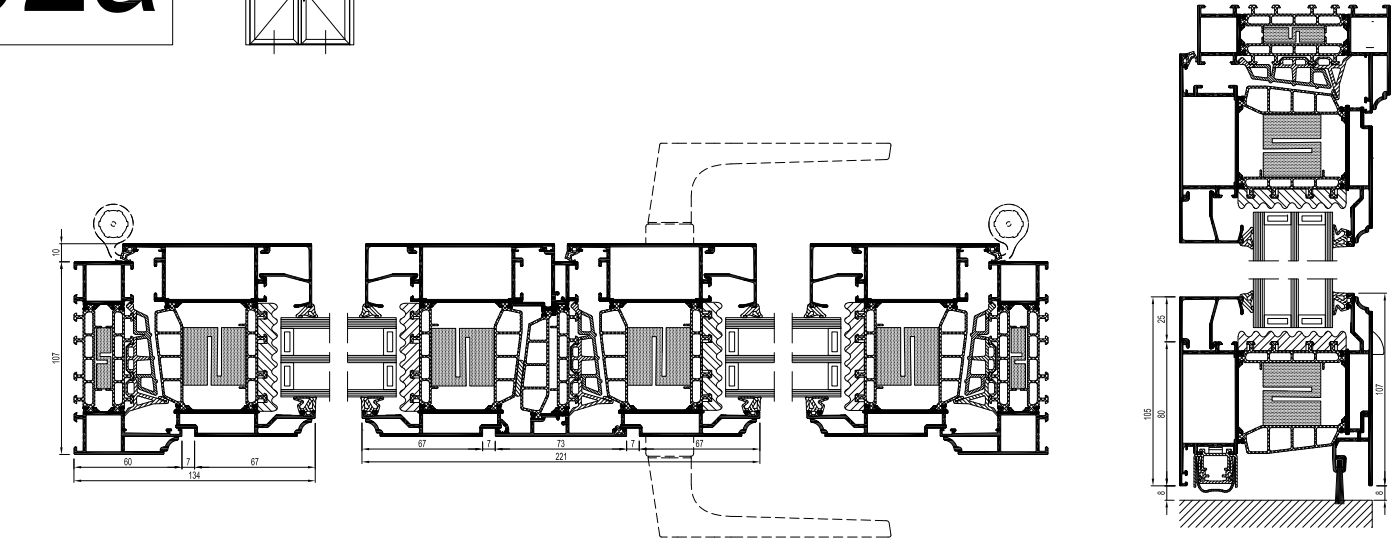

**I** PROFIELOVERZICHT  
APERÇU DES PROFILES  
PROFILE OVERVIEW  
PROFILUEBERSICHT

BUITENKADER  
DORMANT  
OUTER FRAME  
BLENDRAHMEN

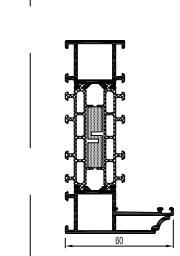

VLEUGEL  
OUVRANT  
VENT  
FLEUGEL

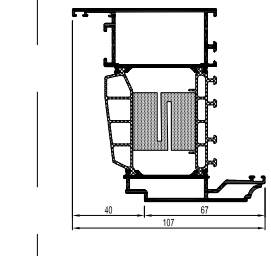
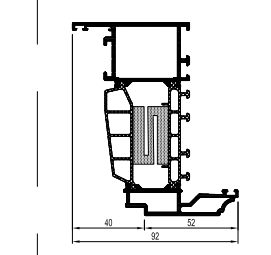
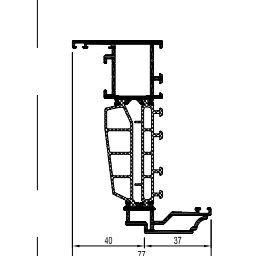

STOLPPROFIEL  
BATTÉE CENTRALE FEN. DOUBLE OUVR.  
DOUBLE CASEMENT PROFILE  
STULPPROFIL

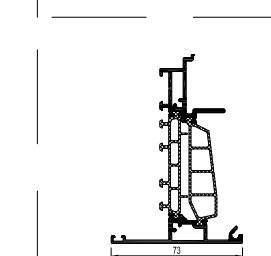

T-PROFIEL  
TRAVERSE  
TRANSOM-MULLION  
SPROSSE

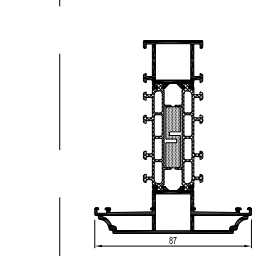

DE PROFIELKEUZE WORDT BEPAALD DOOR DE MAXIMALE AFMETINGEN EN HET MAXIMALE GEWICHT VAN HET ELEMENT. NEEEM CONTACT OP MET UW REYNAERS ALUMINIUM FABRIKANT OM DE JUISTE PROFIELKEUZE TE BEVESTIGEN.

LE CHOIX DU PROFILÉ EST DÉFINI PAR LES DIMENSIONS MAXIMALES ET LE POIDS MAXIMUM DE L'ÉLÉMENT. VEUILLEZ CONTACTER VOTRE FABRICANT REYNAERS ALUMINIUM POUR CONFIRMER LE BON CHOIX DE PROFILÉ.

THE PROFILE SELECTION IS DEFINED BY THE MAXIMUM DIMENSIONS AND WEIGHT OF THE ELEMENT. PLEASE CONTACT YOUR REYNAERS ALUMINIUM FABRICATOR TO CONFIRM THE RIGHT PROFILE SELECTION.

DIE PROFILAUSSWAHL WIRD DURCH DIE MAXIMALEN ABMESSUNGEN UND DAS GEWICHT DES ELEMENTS DEFINIERT. BITTE WENDEN SIE SICH AN IHREN REYNAERS ALUMINIUM HERSTELLER UM DEN RICHTIGEN PROFILAUSSWAHL ZU BESTÄTIGEN.